

MSP16120G1

1200V Silicon Carbide Schottky Diode

Features

- 1200-Volt Schottky Rectifier
- Shorter recovery time
- High-speed switching possible
- High-Frequency Operation
- Temperature-Independent Switching Behavior
- Extremely Fast Switching
- Positive Temperature Coefficient on VF

Benefits

- Higher safety margin against overvoltage
- Improved efficiency all load conditions
- Increased efficiency compared to Silicon Diode alternatives
- Reduction of Heat Sink Requirements
- Parallel Devices Without Thermal Runaway
- Essentially No Switching Losses

Applications

- Switch Mode Power Supplies
- Power Factor Correction
- Motor Drives
- PD Power
- Charging Pile Power
- PV Inverter

Package



Type : TO-220 -2lead

1、Cathode 2、Anode



Absolute Maximum Ratings

$T_c = 25^\circ\text{C}$ unless otherwise noted

Symbol	Parameter	MSP16120G1	Units
VRRM	Repetitive Peak Reverse Voltage	1200	V
VRSM	Surge Peak Reverse Voltage	1200	V
VDC	DC Blocking Voltage	1200	V
IF	Continuous Forward Current @ $T_c=135^\circ\text{C}$	16	A
IFRM	Repetitive Peak Forward Surge Current @ $T_c=25^\circ\text{C}$ $t_p = 10\text{ ms}$, Half Sine Wave	80	A
IFSM	Non-Repetitive Peak Forward Surge Current @ $T_c=25^\circ\text{C}$ $t_p = 10\text{ ms}$, Half Sine Wave	120	A
IF,Max	Non-Repetitive Peak Forward Surge Current @ $T_c=25^\circ\text{C}$, $t_p = 10\text{ us}$, pulse	850	A
Ptot	Power Dissipation @ $T_c=25^\circ\text{C}$ @ $T_c=110^\circ\text{C}$	258 112	W
TJ , Tstg	Operating Junction and Storage Temperature	-55 to +175	$^\circ\text{C}$

Package Marking

Part Number	Top Marking	Package	Packing Method	MOQ	QTY
MSP16120G1	MSP16120G1	T0-220C-2L	Tube	1000	5000

Electrical Characteristics

$T_C = 25^\circ \text{C}$ unless otherwise noted

Symbol	Test Conditions	Test Conditions	Min	Typ	Max	Unit
VF	Forward Voltage	IF=15A, TC=25° C IF=15A, TC=175° C	-	1.5 2.2	1.8 2.5	V
IR	Reverse Current	VR=1200V, TC=25° C VR=1200V, TC=175° C	-	10 20	50 100	μA
QC	Total Capacitive Charge	VR =800V TJ = 25° C $Q_C = \int_0^{V_R} C(V) dv$	-	78	-	nC
C	Total Capacitance	VR =0V, TJ = 25° C, f=1MHz VR =400V, TJ = 25° C, f=1MHz VR =80V, TJ = 25° C, f=1MHz	-	1090 70 53	-	pF
EC	Capacitance Stored Energy	VR=800V	-	40	-	μJ

Thermal Characteristics

Symbol	Parameter	Typ	Unit
RθJC	Thermal Resistance from Junction to Case	0.63	°C/W

Typical Characteristics

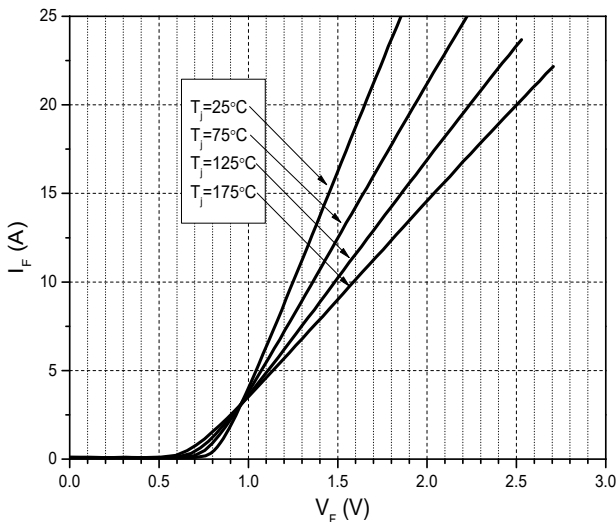

Figure 1. Forward Characteristics

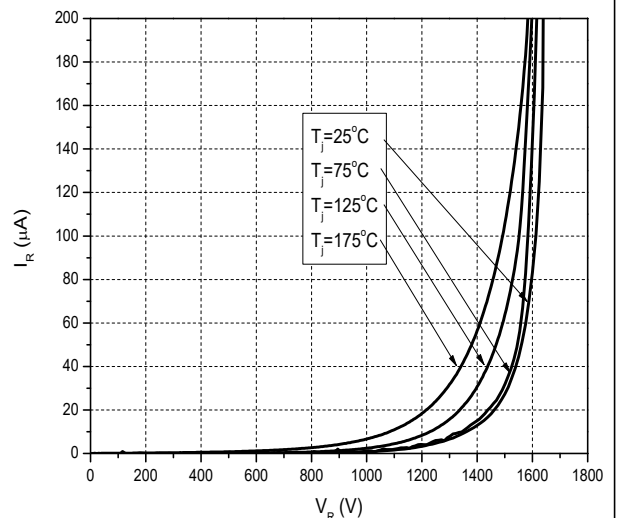

Figure 2. Reverse Characteristics

Typical Characteristics

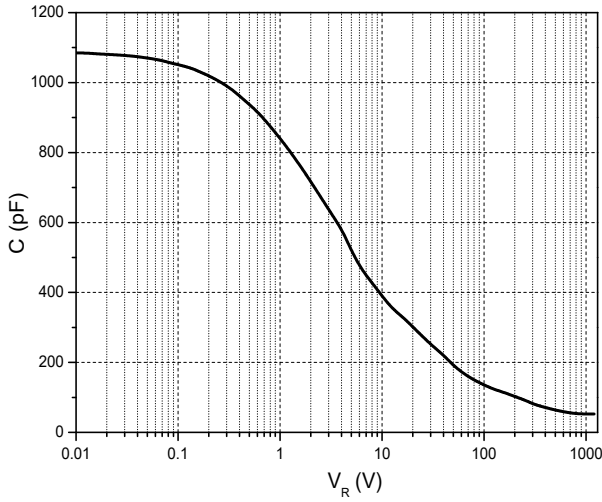

Figure 3. Capacitance vs. Reverse Voltage

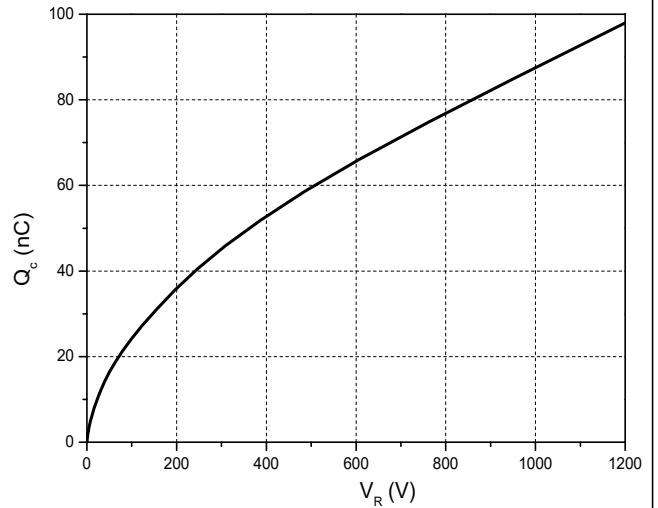

Figure 4. Total Capacitance Charge vs. Reverse Voltage

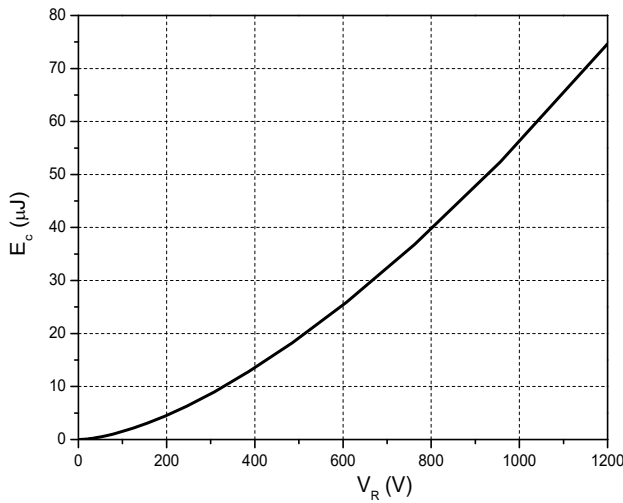

Figure 5. Capacitance Stored Energy

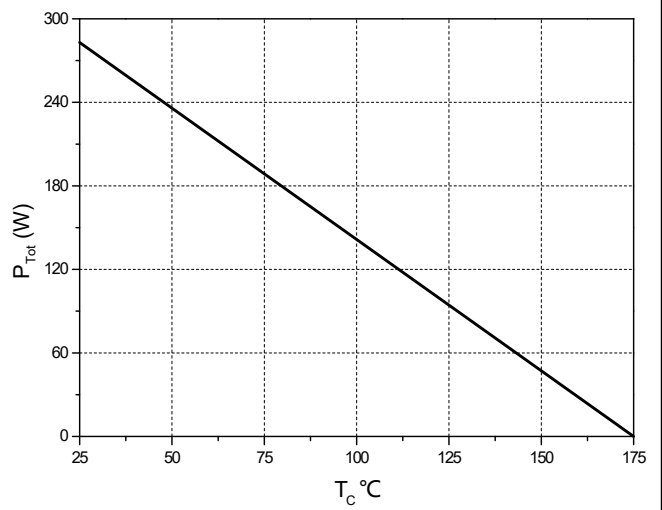

Figure 6. Power Derating

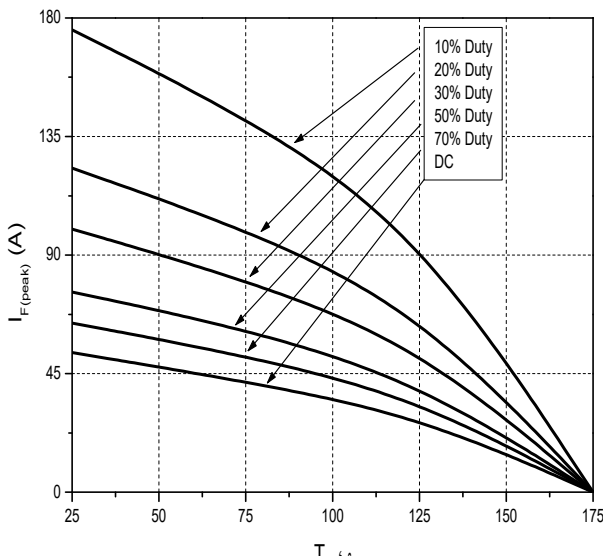

Figure 7. Current Derating

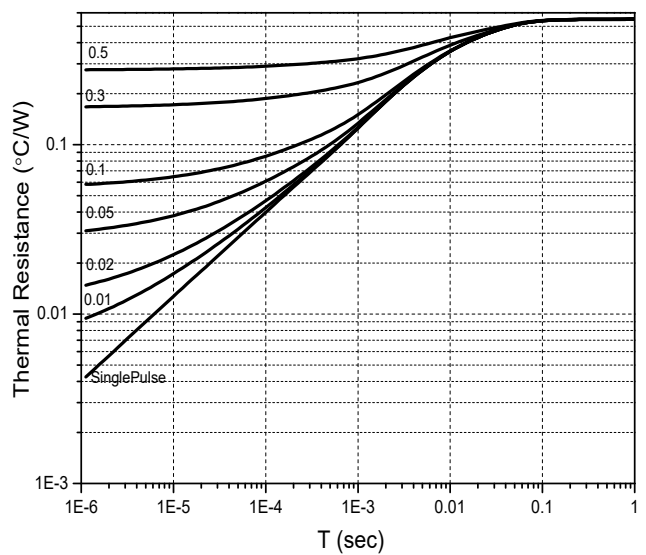
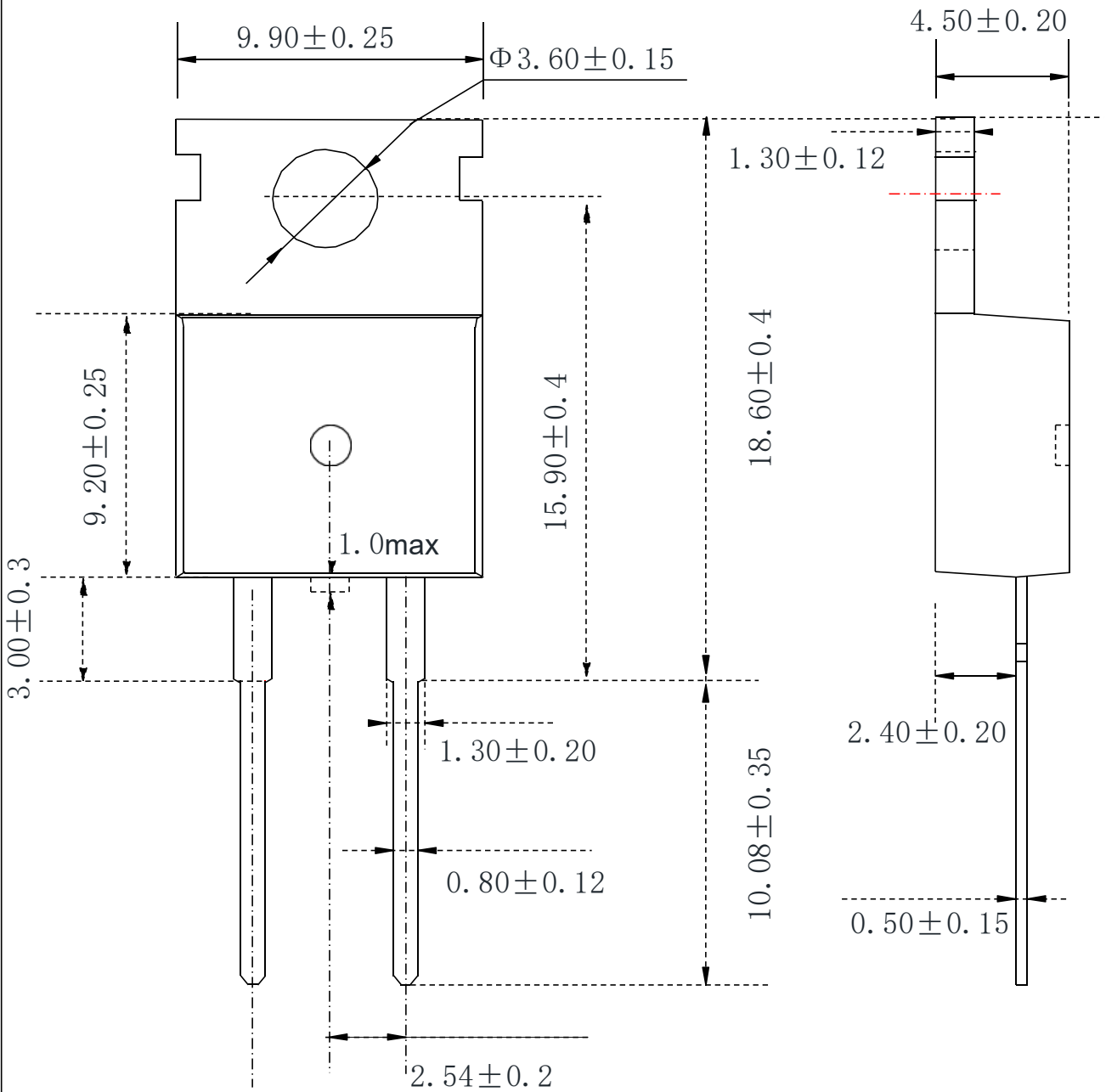

Figure 8. Transient Thermal Impedance

TO-220C-2L OUTLINE



NOTE:

1The plastic package is not marked as smooth surfaceRa=0.1;Subglossy surfaceRa=0.8

2.Undeclared tolerance ± 0.15 ,Unmarked filletRmax=0.25

Disclaimer

The content specified herein is for the purpose of introducing Msemitek's products (here in after "Products"). The information given in this document shall in no event be regarded as a guarantee of conditions or characteristics. Examples of application circuits, circuit constants and any other information contained herein illustrate the standard usage and operations of the Products. The peripheral conditions must be taken into account when designing circuits for mass production.

Msemitek does not assume any liability for infringement of patents, copyrights, or other intellectual property rights of third parties by or arising from the use of the Products or technical information described in this document.

The products are not designed or manufactured to be used with any equipment, device or system which requires an extremely high level of reliability the failure or malfunction of which may result in a direct threat to human life or create a risk of human injury (such as a medical instrument, transportation equipment, aerospace machinery, nuclear-reactor controller, fuel-controller or other safety device). Msemitek shall bear no responsibility in any way for use of any of the Products for the above special purposes.

Although, Msemitek endeavors to improve the quality and reliability of it's products, semiconductor products have specific characteristics such as the occurrence of failure at a certain rate and malfunctions under certain use conditions. Please be sure to implement safety measures to guard them against the possibility of physical injury, and injury or damage caused by fire in the event of the failure of a Msemitek's product.

The content specified herein is subject to change for improvement without notice. When using a Msemitek's product, be sure to obtain the latest specifications.